

ARCH1101

THE BRIDGE

**A MIX OF:
ENGINEERING**

**A MIX OF:
ENGINEERING
ARCHITECTURE**

**A MIX OF:
ENGINEERING
ARCHITECTURE
SCIENCE**

**A MIX OF:
ENGINEERING
ARCHITECTURE
SCIENCE
ART**

PONTE VECCHIO

AN INHABITED BRIDGE

IMPORTANT!!!!!!!!!!!!!!!!!!!!

**THIS
IS
THE
PRECEDENT
FOR ARCH1101
EXP2**









CONSTRUCTION

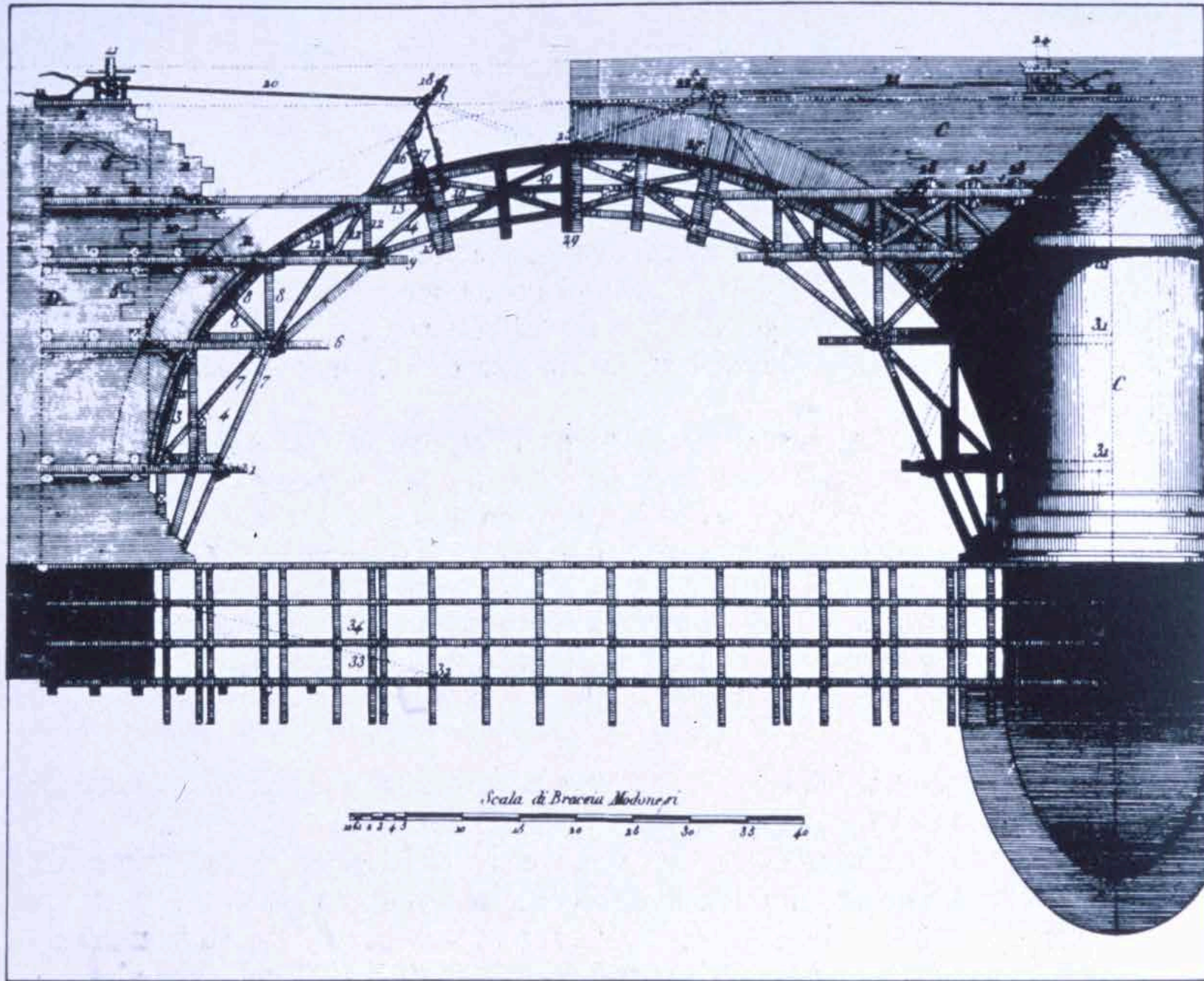

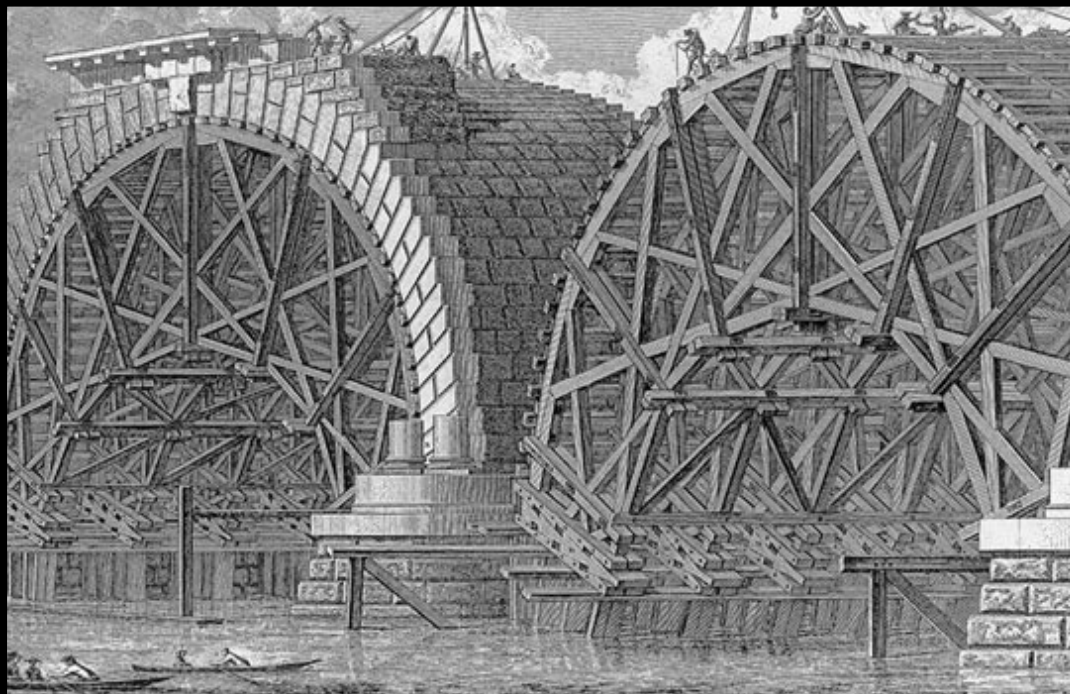

A · VIEW · OF · PART · OF · THE · INTENDED
IN · AVGVST
BY · ROBERT · MYLNE · ARCHITECT

BRIDGE · AT · BLACKFRIARS · LONDON
MDCCLXIII
ENGRAVED · BY · PIRANESI · AT · ROME



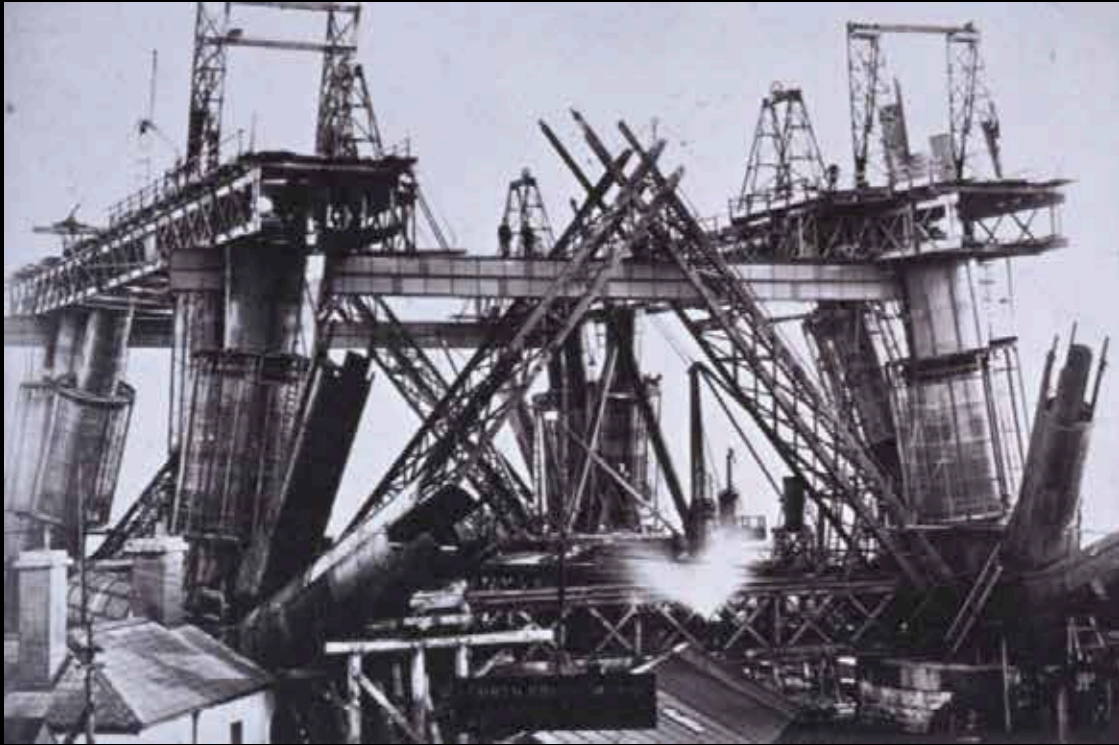











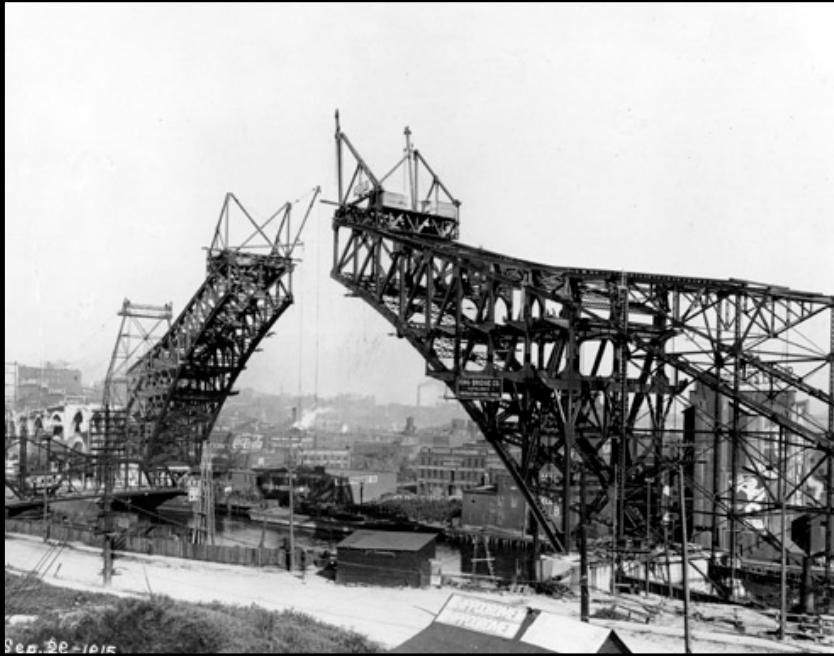



STRUCTURE

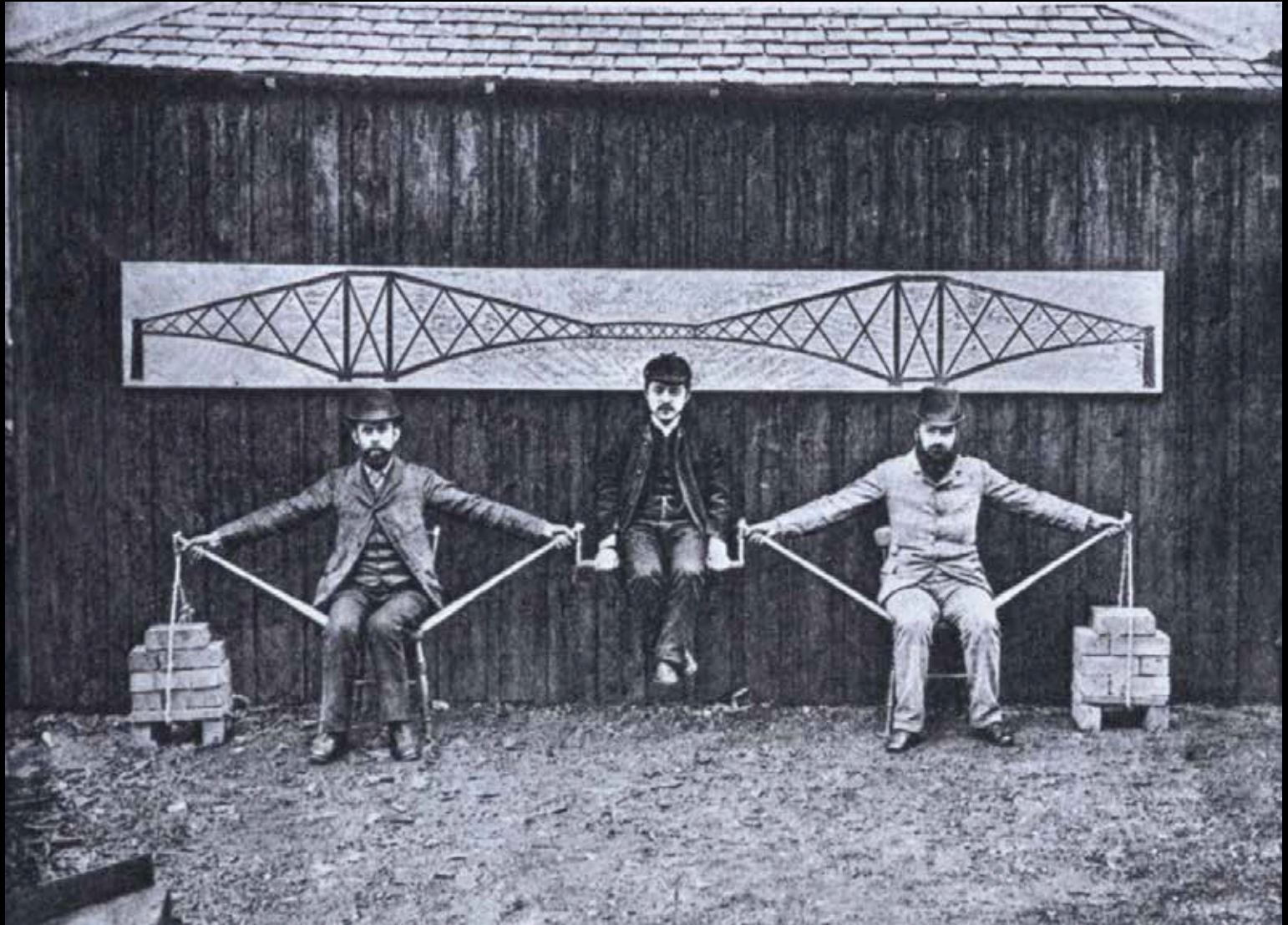

FORTH BRIDGE



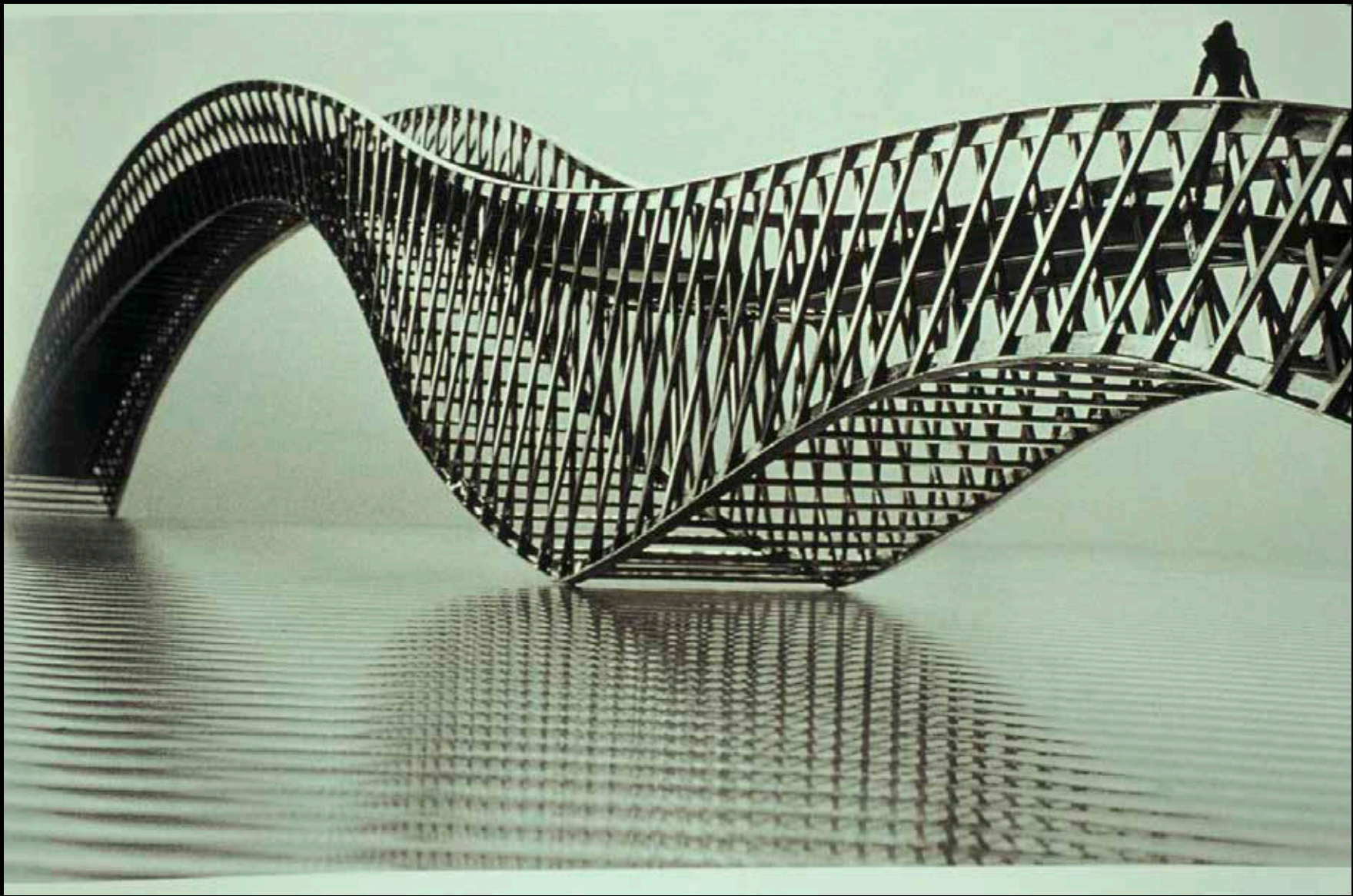

WEST8



Equivalent Stress
x 1e3 psi
Max: 1.104e+003
Min: 1.576e+000
1/31/2007 6:10 PM

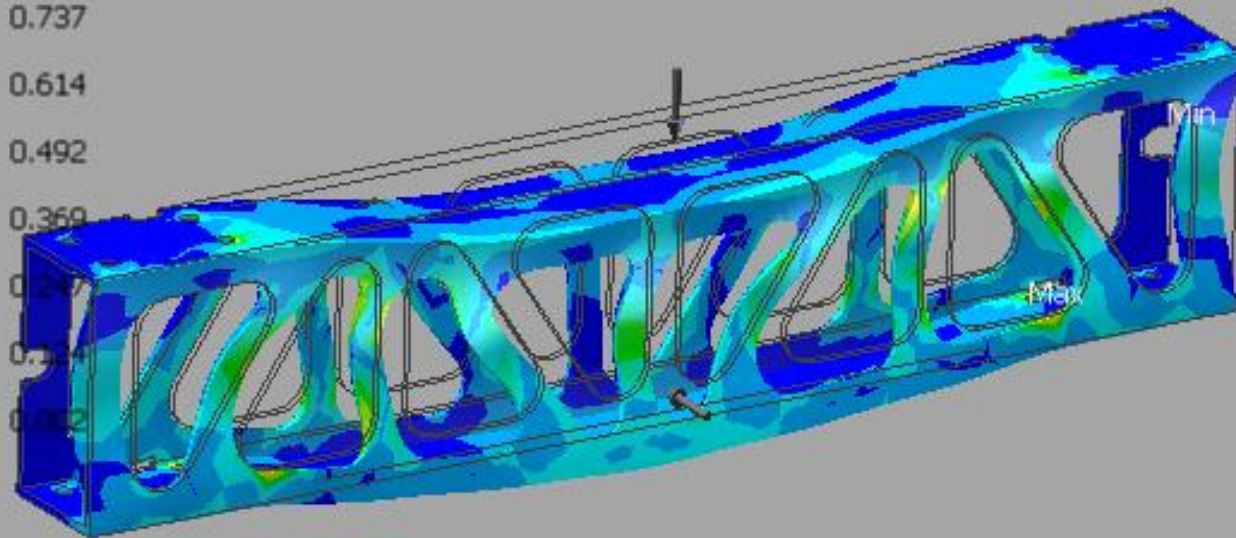

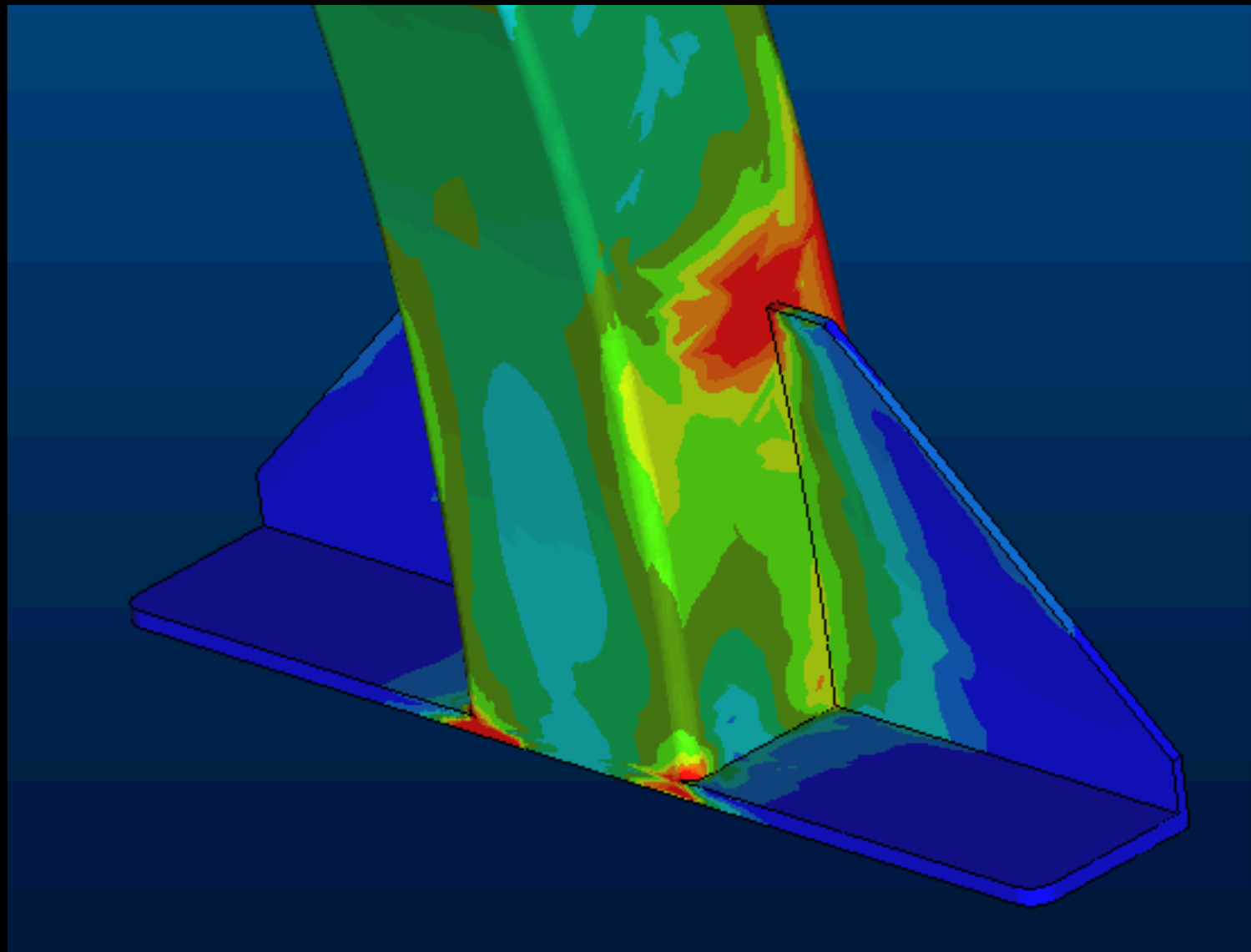

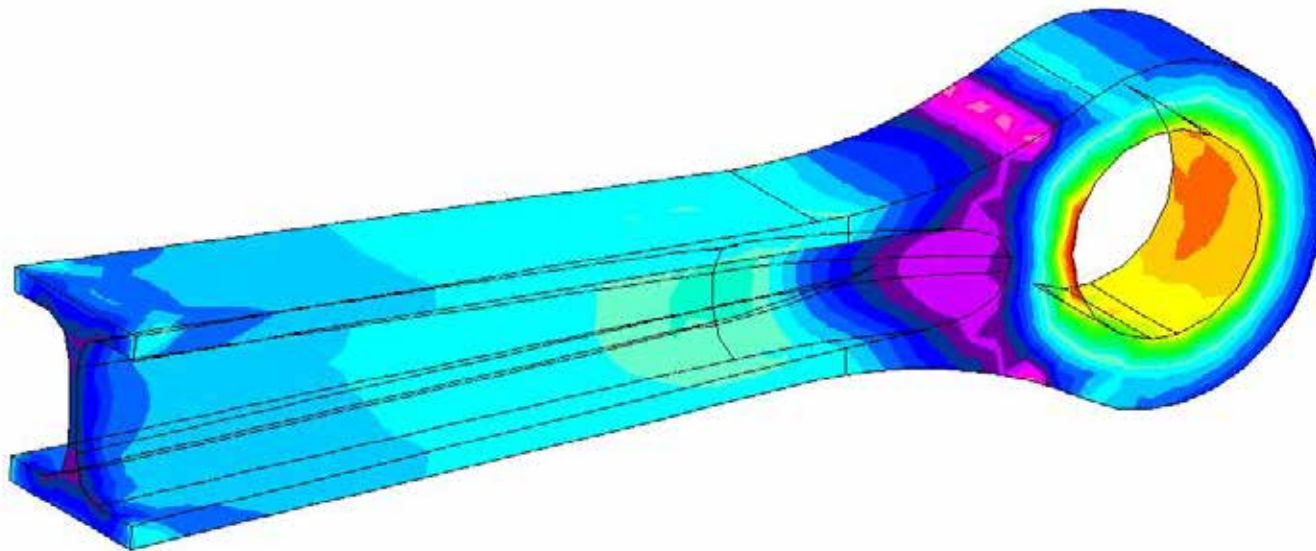

Minimum	
12.5647	
Total Poisson 235.89	
VonMises	
Displacement	
Min	208.6964
Max	259.9976
Min	256.27427
Max	302.5918
Min	82.27969
Max	175.94399
Min	86.09990
Max	86.27091
Min	83.42877
Max	108.09603
Min	80.88064
Max	100.99765
Min	12.57665
Max	80.15826
Min	96.53812
Max	115.78668
Min	79.69788
Max	88.02788
Min	58.25791
Max	58.43771
Min	41.63382
Max	50.99193
Min	23.97744
Max	0.15715
Min	6.97328

FLYING BUTRESS









SANTIAGO CALATRAVA

ENGINEER/ARCHITECT



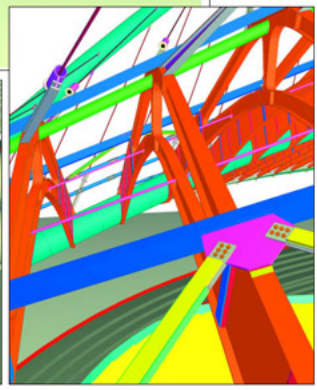
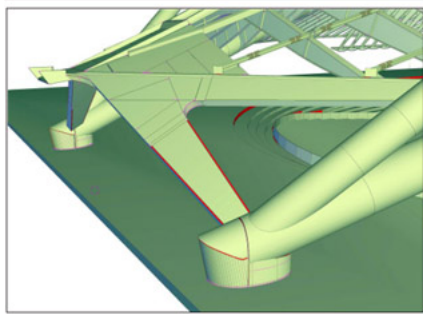
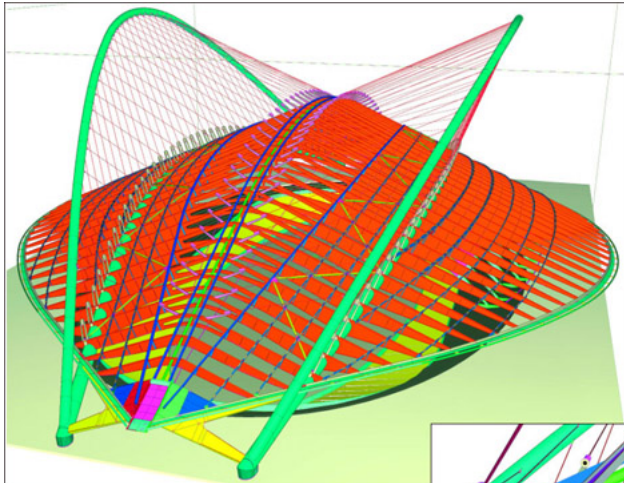

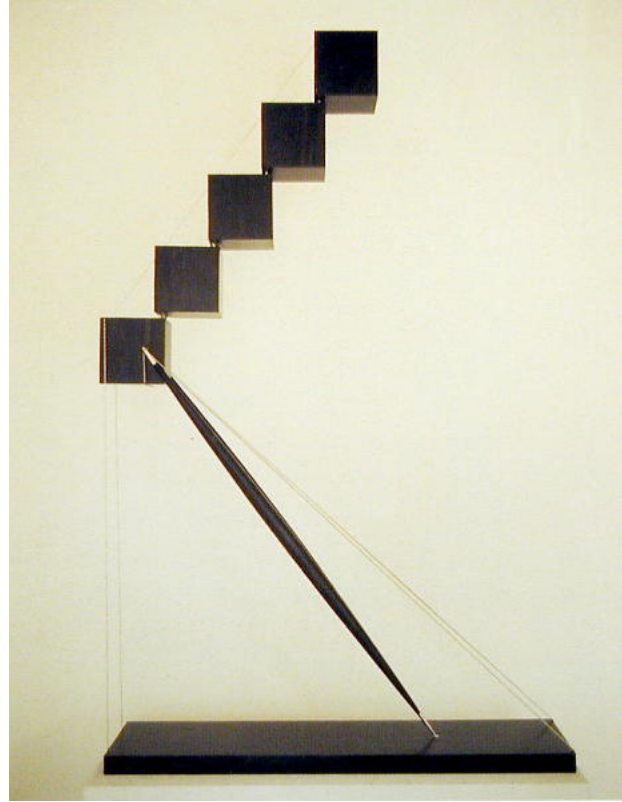
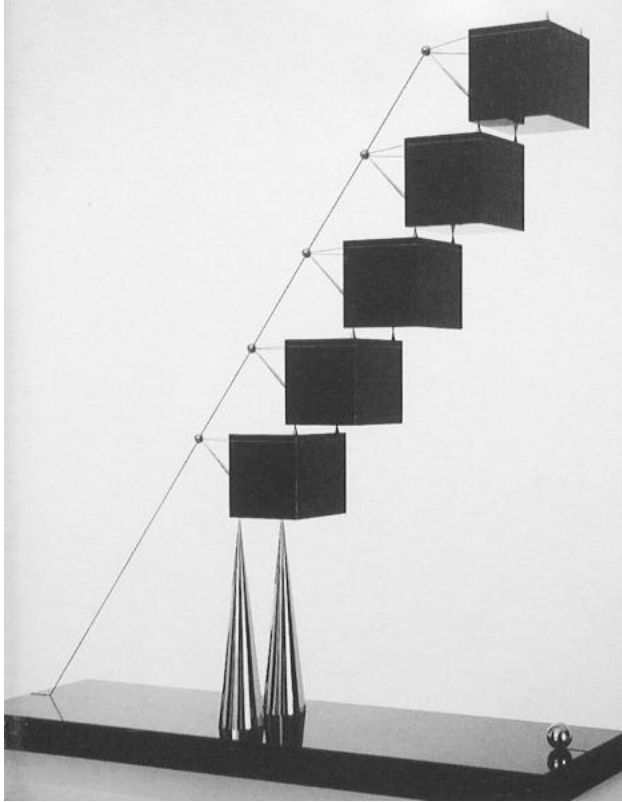

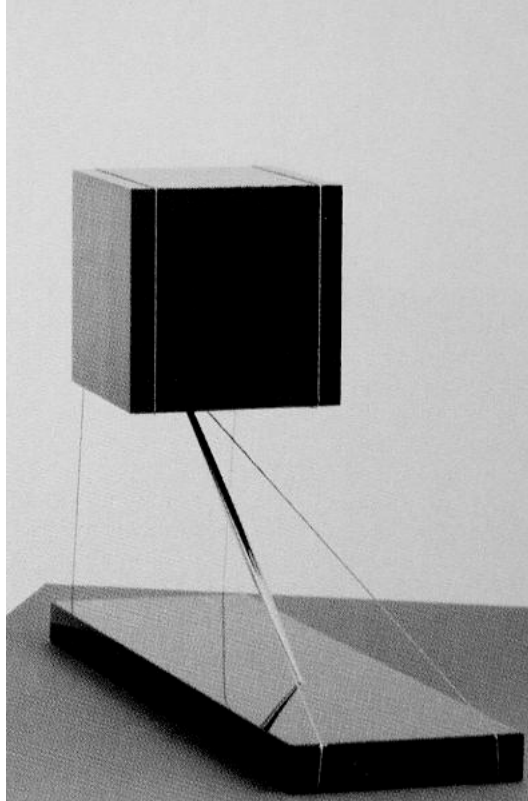

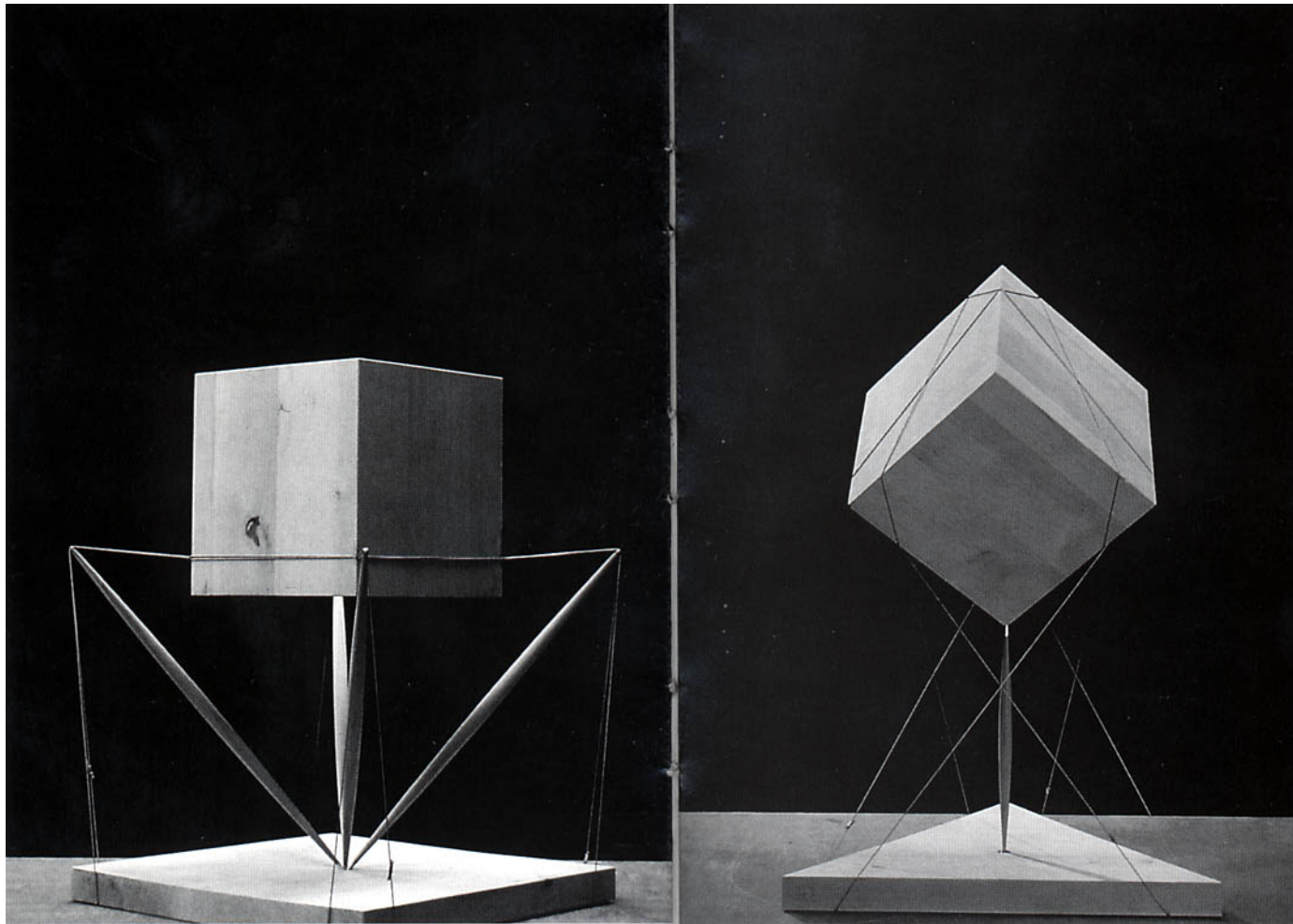

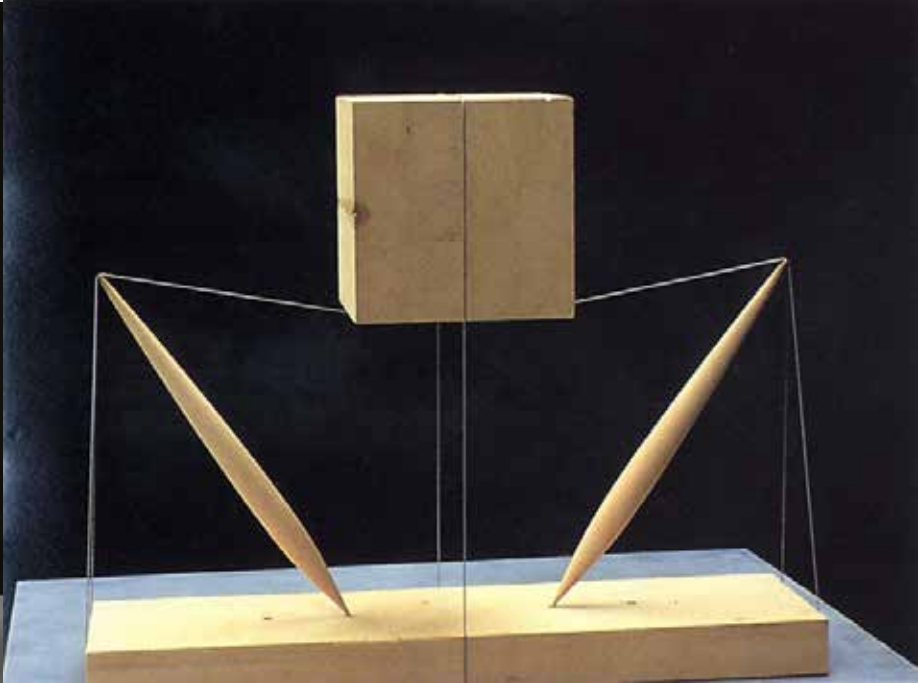
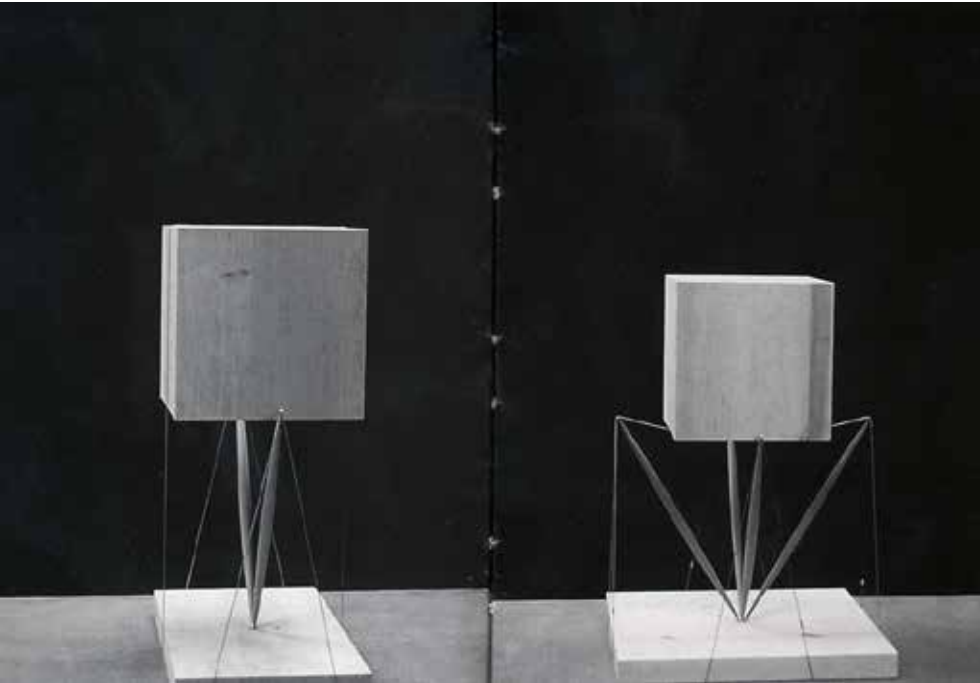

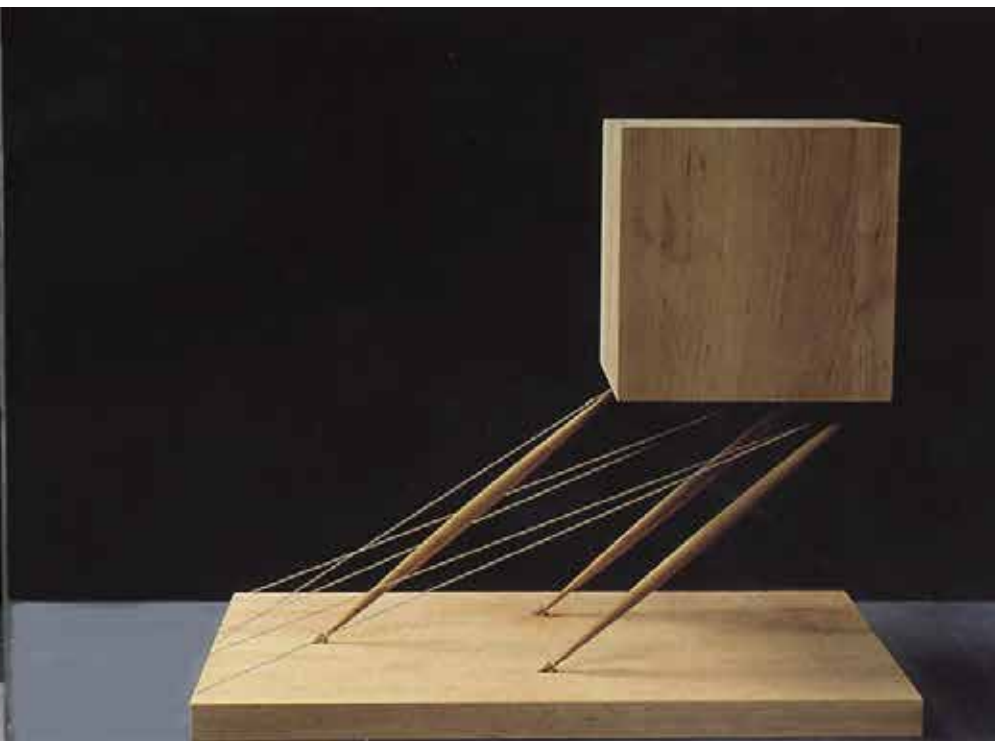
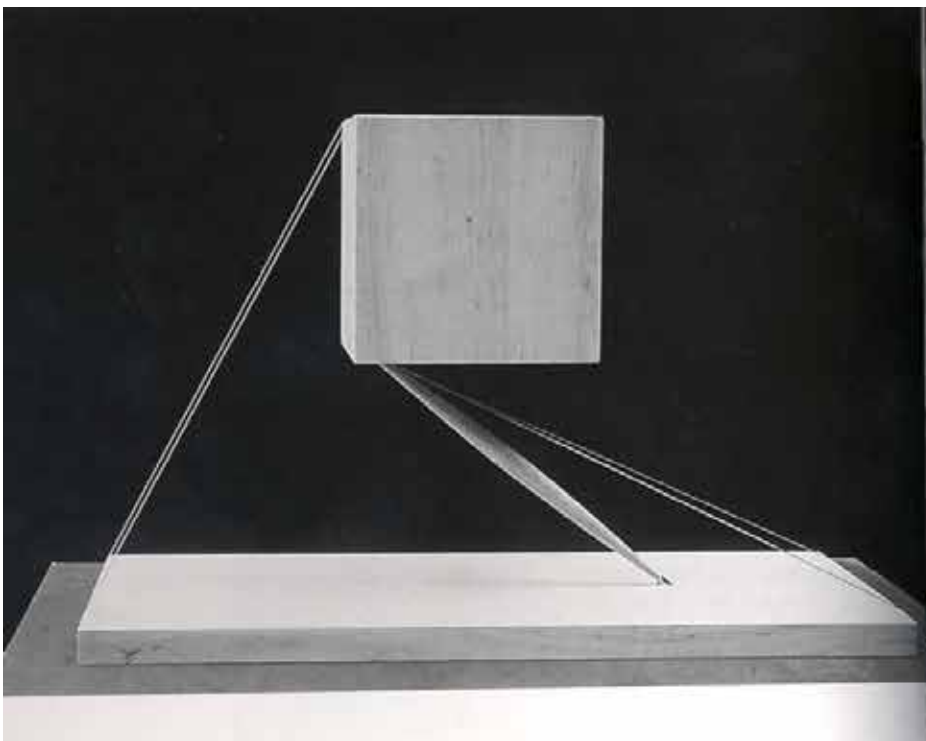

COVERED





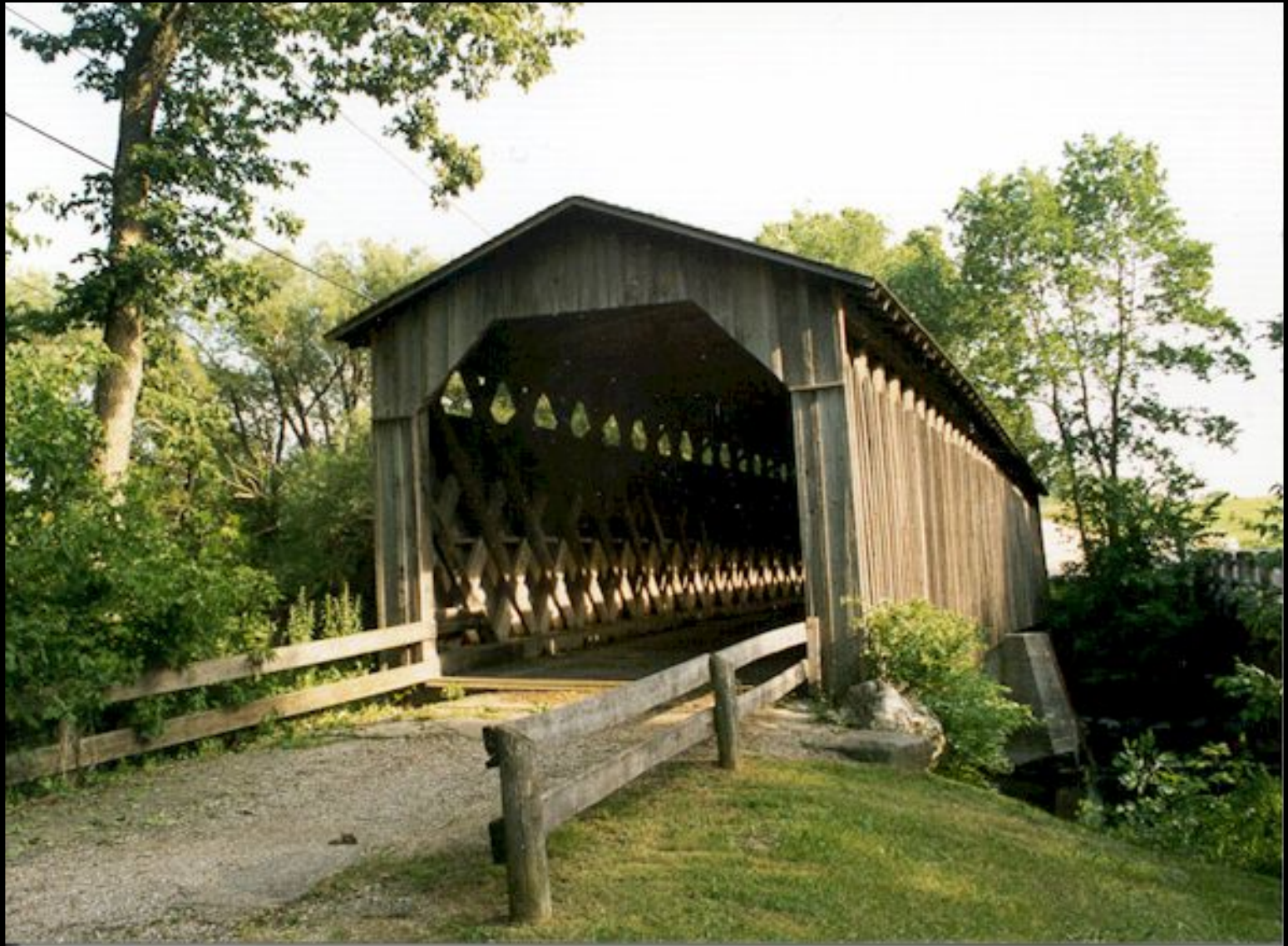





PALLADIO











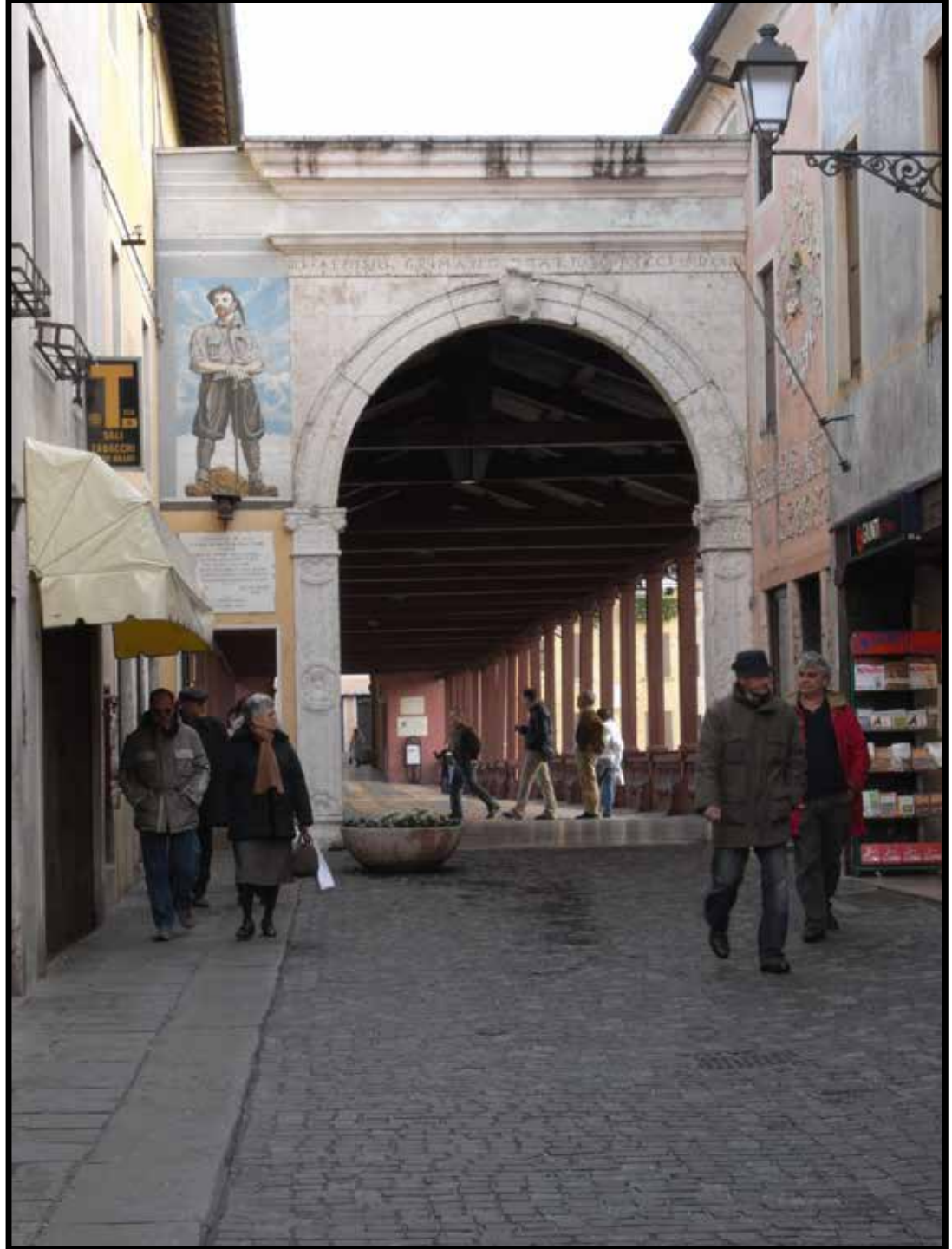







HOUSE















HUGH FERRISS



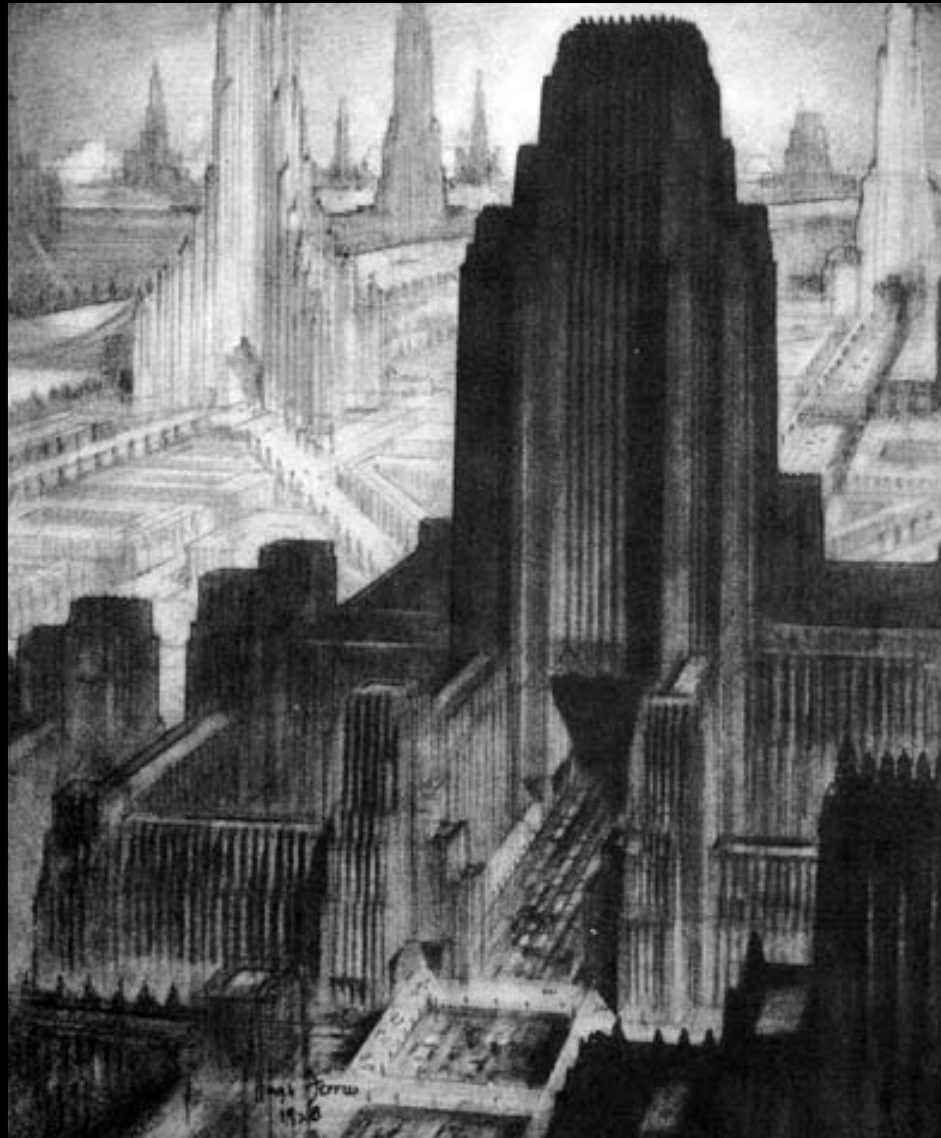

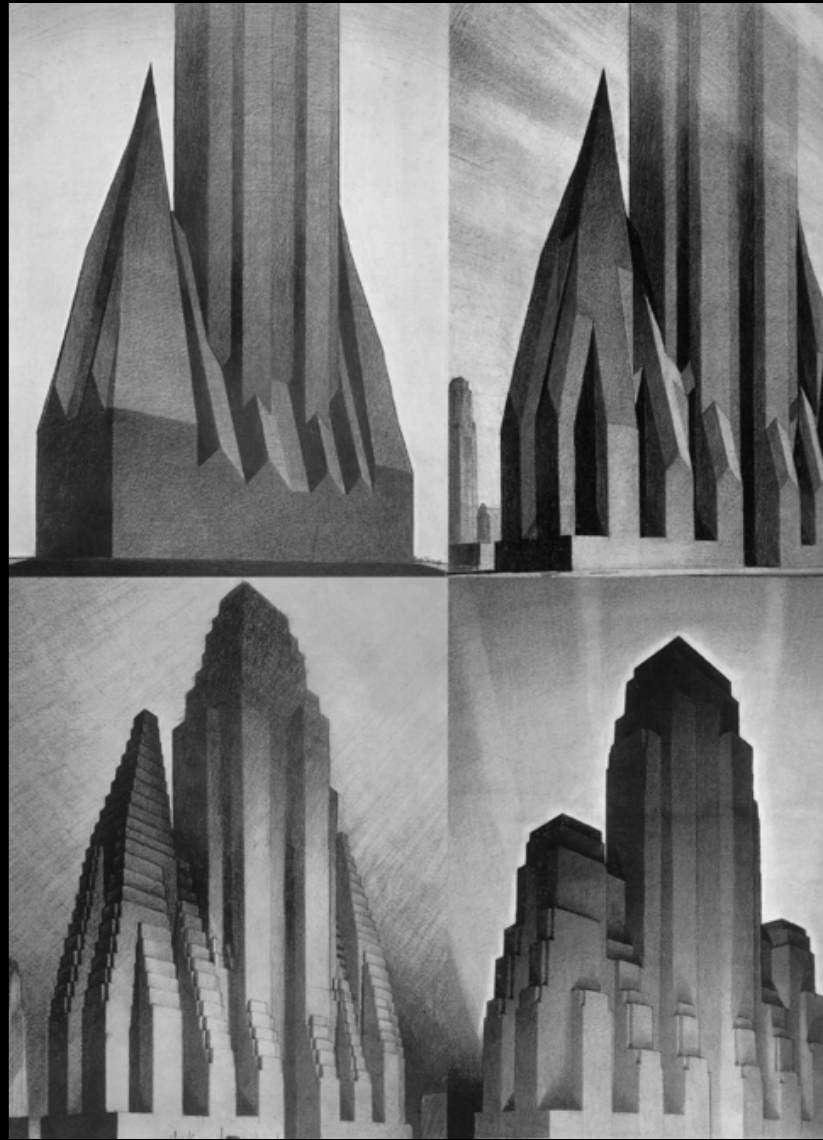

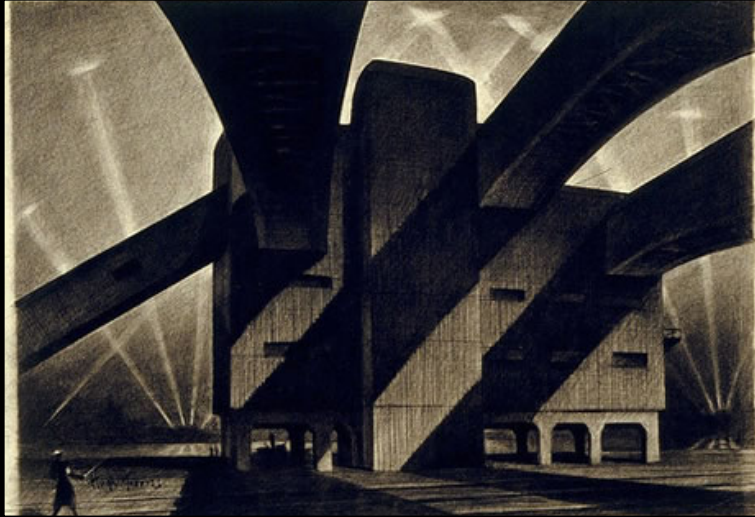
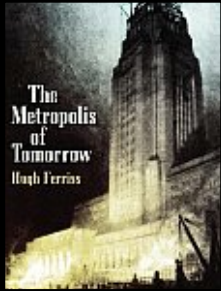

CRAIG ELLWOOD







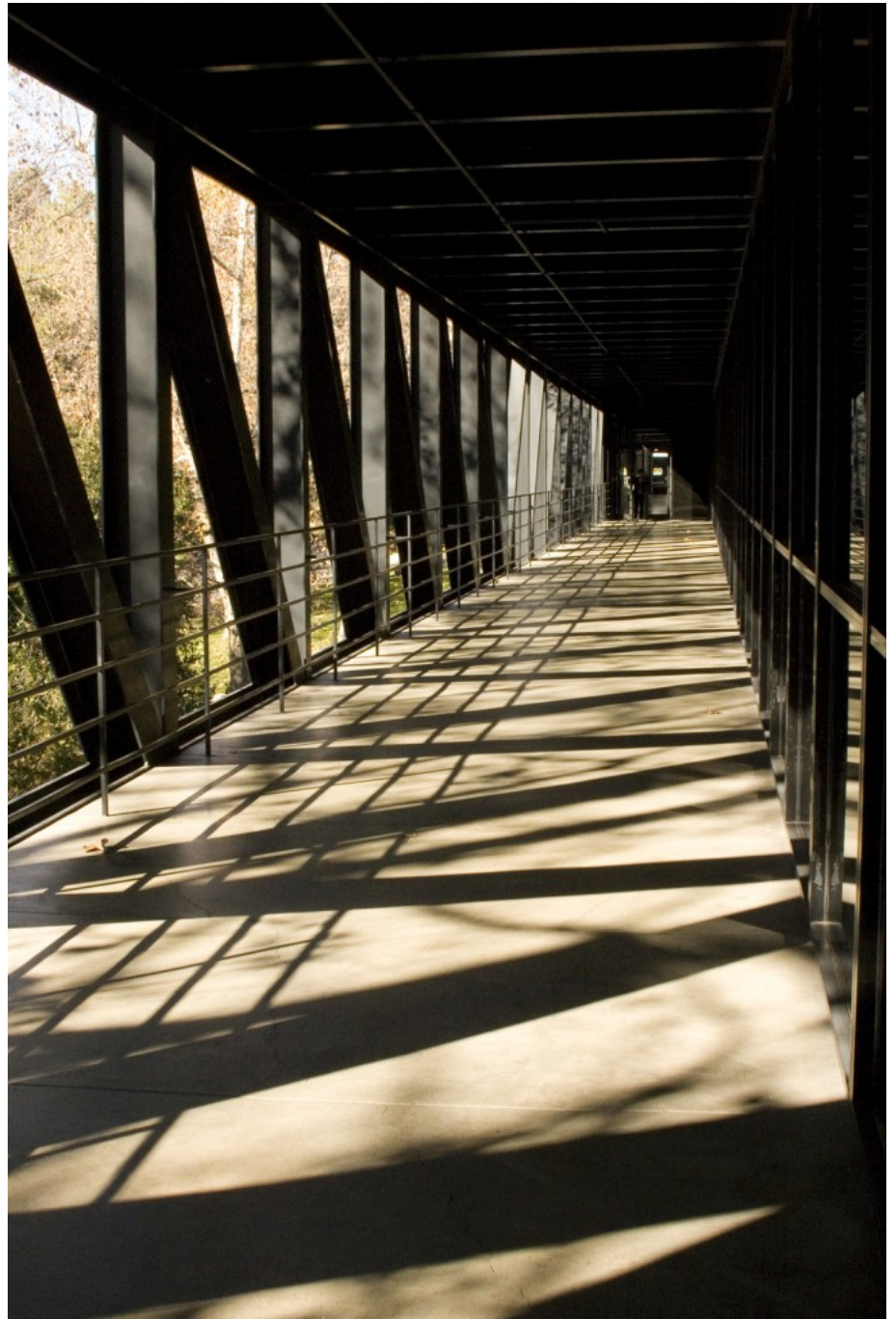

LIGHT













FOSTERS + ARUP

AQUEDUCT



MOTORWAY











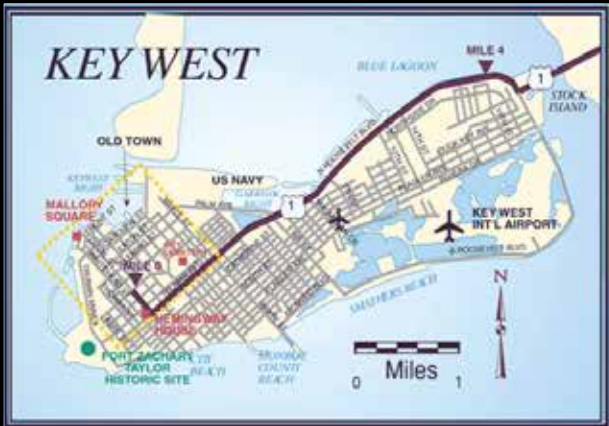

GULF OF MEXICO

ATLANTIC OCEAN

Miles
0 5 10 15
© TRIPmedia Group, Inc.





TALL



LE VIADUC DE MILLAU







ART. M. HEIZER









MALAYSIA





SPAIN

ALFA POLARIS



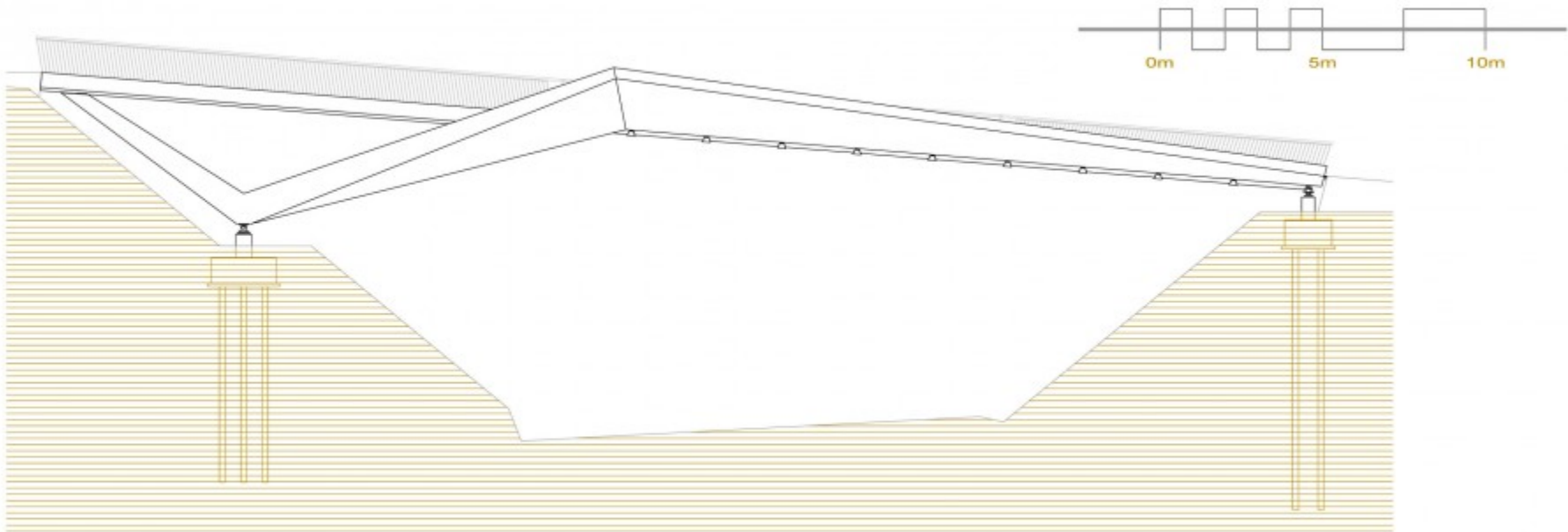

EAST ELEVATION (scale 1/150)







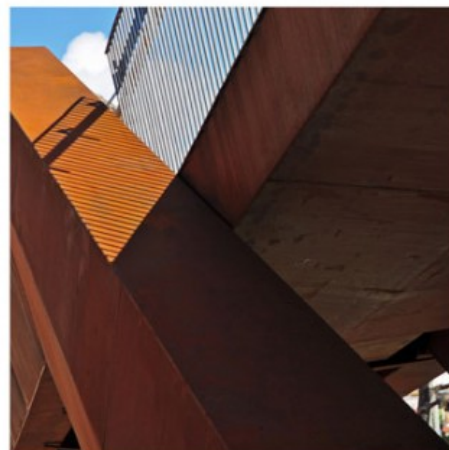
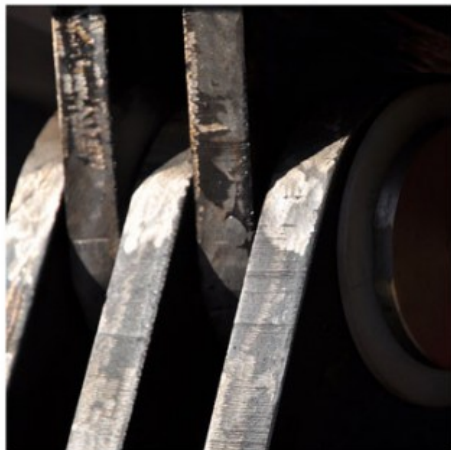
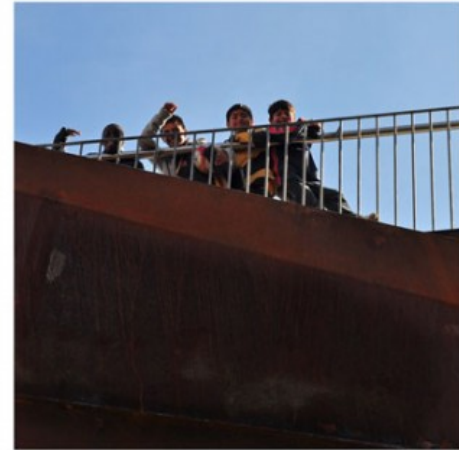
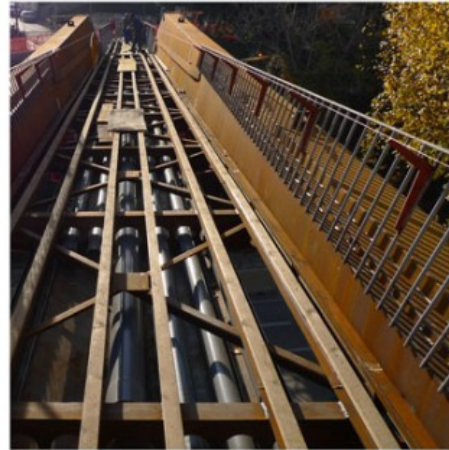
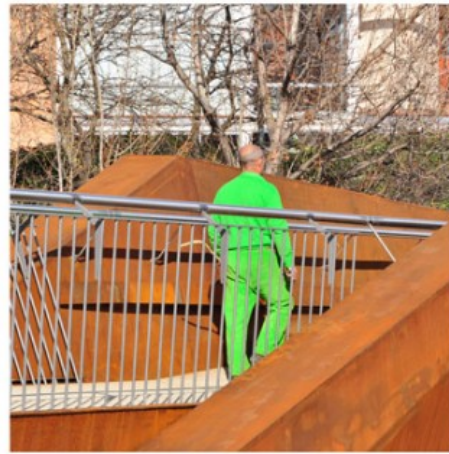

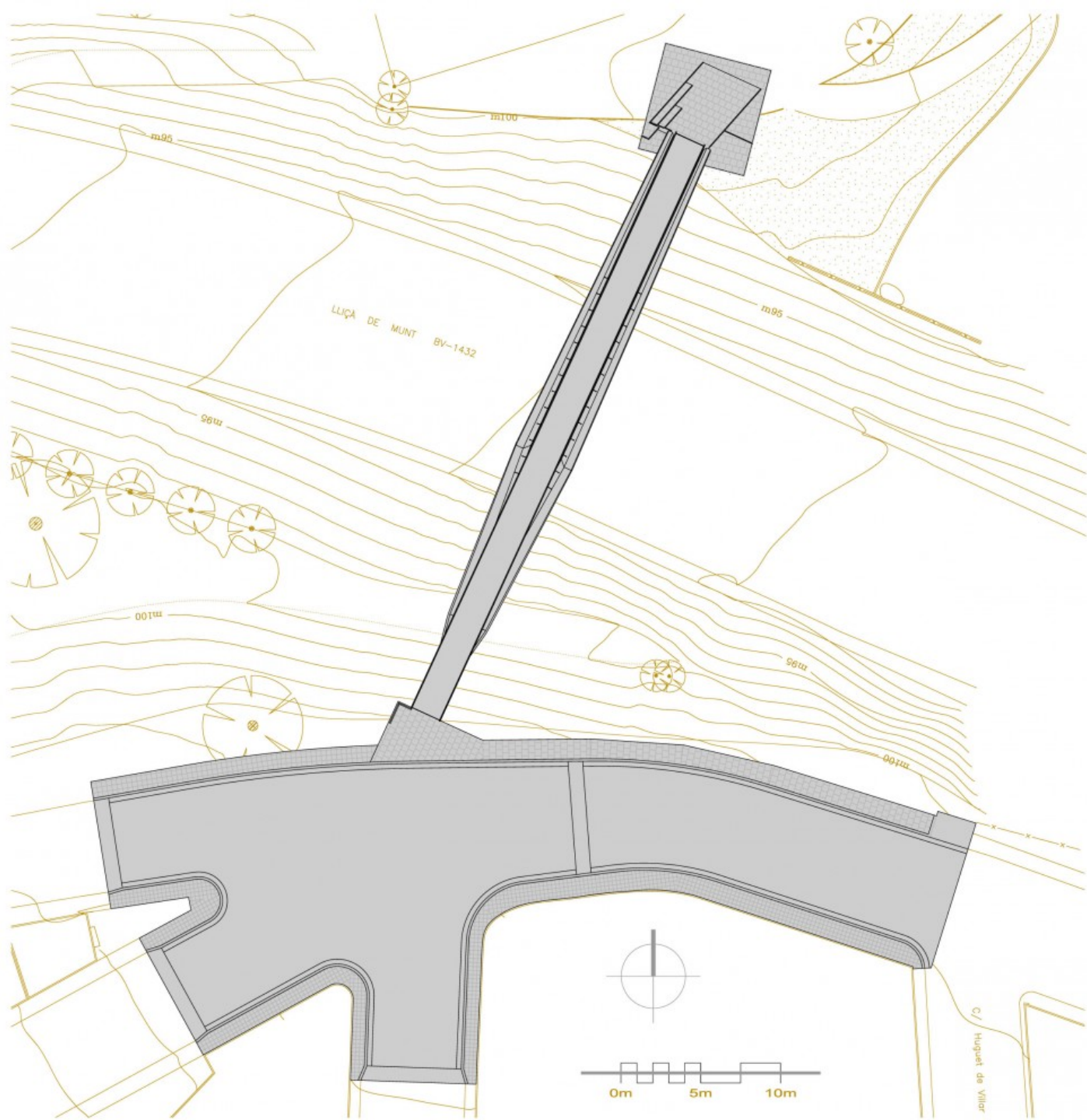

JA.STUDIO.INC





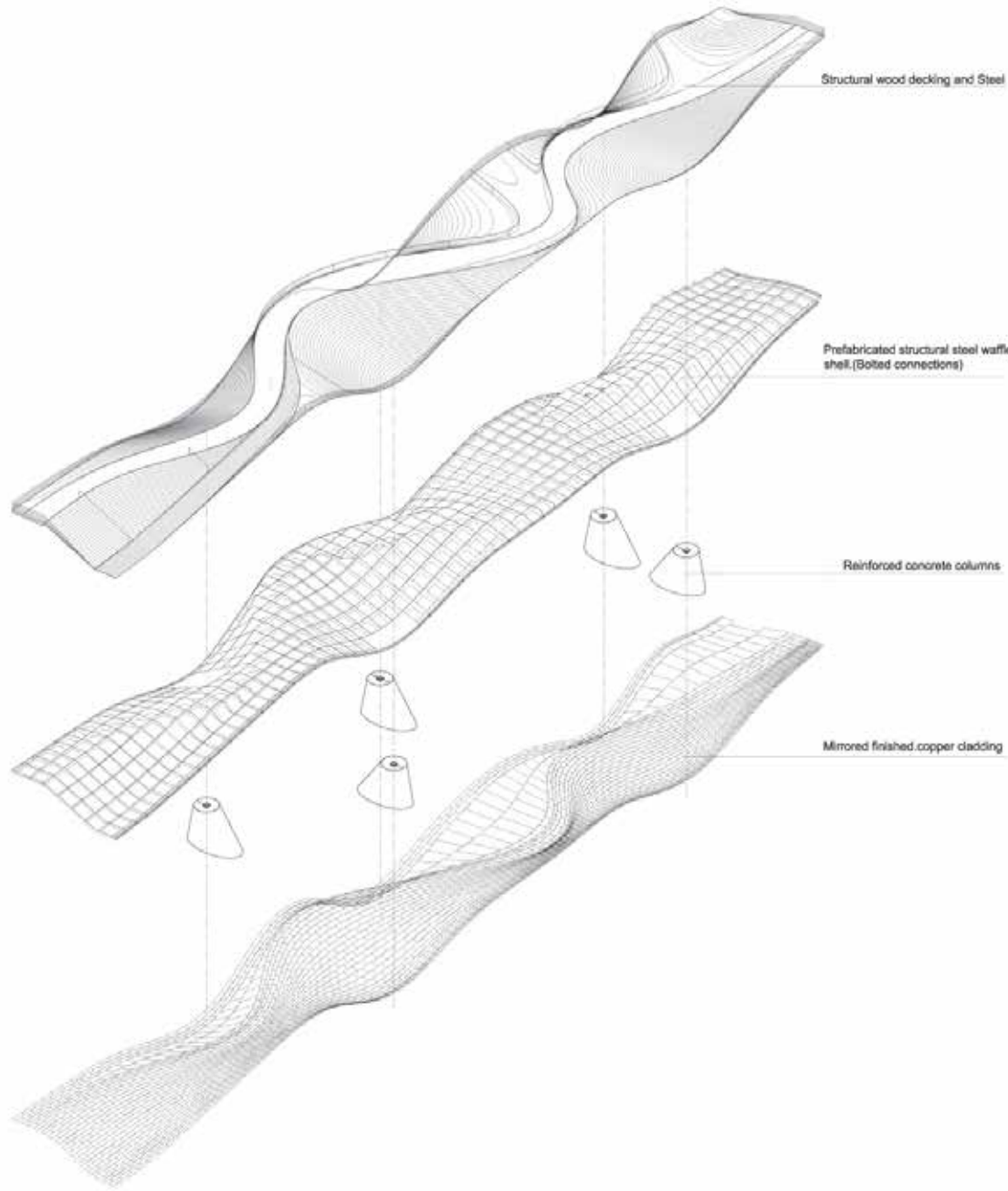

Structural wood decking and Steel

Prefabricated structural steel waffled shell (Bolted connections)

Reinforced concrete columns

Mirrored finished copper cladding

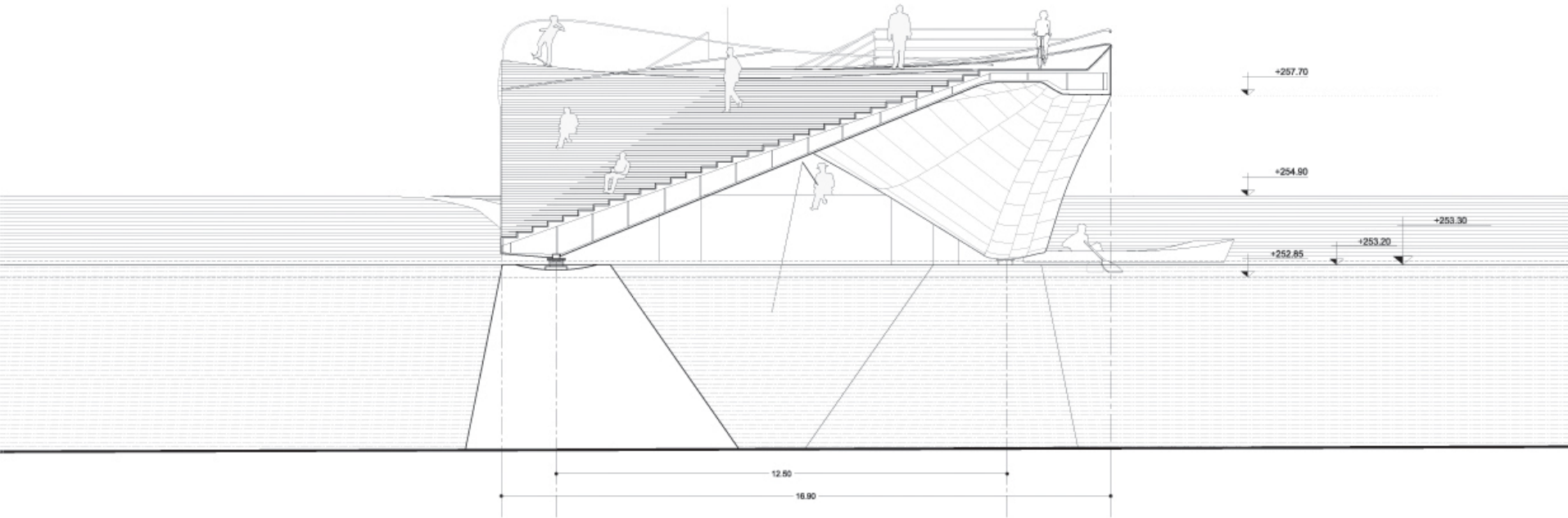





ZAHA HADID



ZARAGOZA





THE BRIDGE